



COUNTY OF SAN MATEO - PLANNING AND BUILDING DEPARTMENT

ATTACHMENT E

BLD2017-01209

**UPDATE GEOLOGIC AND GEOTECHNICAL STUDY
PROPOSED RESIDENTIAL DEVELOPMENT**

COGGINS PROPERTY

APN 083-310-150

COGGINS ROAD

SAN MATEO COUNTY, CALIFORNIA

RECEIVED

JUN 09 2017

SAN MATEO COUNTY Prepared For:
BUILDING INSPECTOR

**Mr. Corey and Mrs. Marci Coggins
Coggins Family Partnership
431 Burgess Drive, Suite 200
Menlo Park, California**

28 November 2016
Document Id. 00514U-02R1

This document is protected under Federal Copyright Laws. Unauthorized use or copying of this document by anyone other than the client(s) is strictly prohibited. If use or copying is desired by anyone other than the client, complete the "APPLICATION TO USE" attached to this document and return it to C2Earth, Inc.

UPP GEOTECHNOLOGY

a division of **C2EARTH, INC.**

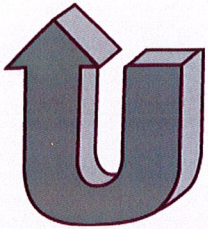

UPP GEOTECHNOLOGY

Engineering Geology • Geotechnical Engineering

a division of C2EARTH, INC.

28 November 2016
Document Id. 00514U-02R1
Serial No. 17837

Mr. Corey and Mrs. Marci Coggins
Coggins Family Partnership
431 Burgess Drive, Suite 200
Menlo Park, CA 94025

SUBJECT: UPDATE GEOLOGIC AND GEOTECHNICAL STUDY
PROPOSED RESIDENTIAL DEVELOPMENT
COGGINS PROPERTY
APN 083-310-150
COGGINS ROAD
SAN MATEO COUNTY, CALIFORNIA

Dear Mr. and Mrs. Coggins:

As you requested, we have performed an update geologic and geotechnical study for the proposed residential development of one parcel (APN 083-310-150) on Coggins Road within your ranch in the La Honda community of unincorporated San Mateo County, California. The accompanying report presents the results of our study and testing, and our conclusions and recommendations concerning the geotechnical engineering aspects of the project. The findings and recommendations presented in this report are contingent upon our review of the final grading, foundation, and drainage control plans; our observation of the grading; and the installation of the foundation and drainage control systems.

This report includes information that is vital to the success of your project. We strongly urge you to thoroughly read and understand its contents. Please refer to the text of the report for detailed findings and recommendations.

Sincerely,
Upp Geotechnology
a division of C2Earth, Inc.

Christopher R. Hundemer, Principal
Certified Engineering Geologist 2314
Certified Hydrogeologist 882

Craig N. Reid, Principal
Certified Engineering Geologist 2471
Registered Geotechnical Engineer 3060



THIS DOCUMENT HAS
BEEN DIGITALLY SIGNED

Distribution: Addressee (4 hard copies via mail and via e-mail to cogginshouse@aol.com)

TABLE OF CONTENTS

1. INTRODUCTION.....1

2. SCOPE OF SERVICES.....1

3. GEOLOGY AND SEISMICITY.....2

 3.1. Geology.....2

 3.2. Regional Landsliding.....3

 3.3. Seismicity.....4

4. SITE CHARACTERIZATION.....5

 4.1. Regional Setting.....5

 4.2. Site Description.....6

 4.3. Subsurface.....6

 4.4. Groundwater.....7

 4.5. Laboratory Testing.....7

5. LANDSLIDE SCREENING ANALYSES.....7

6. FINDINGS.....8

 6.1. Proposed Building Site.....8

 6.2. Proposed Leachfield.....9

 6.3. Slope Stability.....9

 6.4. Seismicity.....10

7. RECOMMENDATIONS.....10

 7.1. Location of Proposed Improvements.....10

 7.2. Seismic Design Criteria.....10

 7.3. Earthwork.....11

 7.4. Foundations.....14

 7.5. Drainage.....16

8. PLAN REVIEW AND CONSTRUCTION OBSERVATION.....17

BIBLIOGRAPHY

LIST OF AERIAL PHOTOGRAPHS

FIGURES AND TABLE

APPLICATION TO USE

APPENDIX A

1. INTRODUCTION

This report presents the results of our update geologic and geotechnical study for the proposed residential development of a single parcel (APN 083-310-150) on Coggins Road within your ranch in the La Honda community of unincorporated San Mateo County, California (see Figure 1, Site Location Map). We previously performed a geotechnical study for the development of three adjoining parcels within your ranch (one of which was the subject parcel), and issued the results of that study in our report dated 17 October 1988 (Serial No. 3214).

Subsequently, two of the three lots (one east and one west of the subject parcel) were developed. We provided supplemental geotechnical engineering, plan review and construction observation services for those two parcels between 1999 and 2005. We understand that you now wish to proceed with developing the remaining undeveloped parcel. The proposed development will include constructing a single-story manufactured home with a two-car garage and a detached manufactured secondary dwelling within the northern central portion of the parcel. The structures will be serviced by an on-site septic system (leachfield) that we understand has already been installed.

The purpose of our study was to perform geologic and geotechnical assessments based upon data collected during our former study, and to develop updated findings and recommendations for the earthwork and foundation engineering aspects of the proposed development. We issue this report with the understanding that it is your responsibility (as the owner) to ensure that the information and recommendations contained in this report are brought to the attention of the project architect and engineer and are incorporated into the plans and specifications of the development. You must also ensure that the contractor and sub-contractors follow the recommendations during construction.

2. SCOPE OF SERVICES

We conducted this study in accordance with the scope and conditions presented in our confirming agreement dated 18 October 2016 (Document Id. 00514U-02P1). The methodology of our evaluation is discussed in the body of this report. We make no other warranty, either expressed or implied. Our scope of services for this update study included:

- reviewing selected geologic literature, aerial photographs, and our previous reports, letters, and construction files for the site and other properties within the site vicinity to evaluate the prevailing geotechnical and geologic conditions;
- performing an engineering geologic reconnaissance of the site in the area of the proposed improvements;
- preparing an updated partial site plan and geologic cross-section;
- analyzing geologic and geotechnical engineering properties from previously collected data; and
- preparing this report.

We have prepared this update report as a product of our service for your exclusive use in designing and constructing the proposed improvements. Other parties may not use this report, nor may the report be used for other purposes, without prior written authorization from Upp Geotechnology, a division of C2Earth, Inc (C2).

Because of possible future changes in site conditions or the standards of practice for geotechnical engineering and engineering geology, the findings and recommendations of this report may not be considered valid beyond three years from the report date, without review by C2. In addition, in the event that any changes in the nature or location of the proposed improvements are planned, the conclusions and recommendations of this report may not be considered valid unless we review such changes, and modify or verify in writing the conclusions and recommendations presented in this report.

Our study excluded an evaluation of hazardous or toxic substances, corrosion potential, chemical properties, and other environmental assessments of the soil, subsurface water, surface water, and air on or around the subject property. The lack of comments in this report regarding the above does not indicate an absence of such substances and/or conditions.

3. GEOLOGY AND SEISMICITY

We reviewed selected geologic maps, aerial photographs, our prior reports for the subject property and other properties within La Honda, and our previous letters and construction observations data for the development of two adjacent parcels within your ranch to evaluate the prevailing geologic conditions of the site and in the vicinity. The Regional Geologic Map and La Honda Landslide Map are presented on Figures 2 and 3, respectively.

3.1. Geology

The subject property is located on the western side of the central Santa Cruz Mountains, a northwest-trending range within the California Coast Ranges geomorphic province (see Figure 1). The community of La Honda is located in a bowl-shaped valley on the east side of the southerly-flowing La Honda Creek. The subject parcel occupies a gently sloping, west-plunging spur ridge on the southeast side of the bowl-shaped valley.

According to the Geology of the Onshore Part of San Mateo County, California (Brabb et al., 1998), the bowl is underlain by Pliocene and upper Miocene age (approximately 2.6 to 11.6 million years old) Tahana member of the Purisima formation bedrock at depth (see Figure 2, Regional Geologic Map). This bedrock consists predominantly of sandstone and siltstone with some silty mudstone. Where fresh, this material has a distinctive greenish-gray color, weathering to white or buff. The mudstone generally is dark gray.

The originally flat lying sedimentary bedrock has been uplifted, tilted, and folded by the mountain-building processes that formed the Santa Cruz Mountains. A review of the geologic maps show that bedding attitudes in the site vicinity are sparse, but generally consistent. Approximately 2,500 feet to the east and 3,300 feet to the northwest of the site, the bedrock

bedding strikes (is oriented) approximately northwest and dips (slopes downward) 22 and 10 degrees (respectively) to the west / southwest (see Figure 2).

The Purisima formation bedrock overlies the Mindego Basalt, which is mapped near the ground surface north of the La Honda community. The contacts between these units are inter-fingered or unconformable. The Mindego basalt formation is described as Miocene and Oligocene age (approximately 5.3 to 33.9 million years old) volcanic rock and includes both extrusive and intrusive volcanic rocks. The extrusive rock is composed of hard dark gray blocks in a matrix of volcanic glass or calcite. The blocks are hard, but the matrix weathers soft to depths as great as 50 feet. The intrusive rocks are dark greenish gray and hard where fresh, weathering to a firm orange brown.

The bedrock is overlain by slope debris (colluvium) on the subject property and across most of the hillside areas in the site vicinity. Where the colluvium is located on moderate to steep slopes, it is subject to downhill creep, a process by which the soil moves downslope at an imperceptibly slow rate as a result of gravity.

3.2. Regional Landsliding

As noted above, a large portion of the community of La Honda is located largely within a mapped pre-historic landslide (see Figure 3, La Honda Landslide Map). We previously reviewed six pairs of historic stereo-paired aerial photographs covering the La Honda area, dating from 1941 through 1995. The photos show that the topography of the La Honda area has a pronounced landslide geomorphology with several identifiable landslides of varying ages. The relative ages of landslides are interpreted largely based on the "freshness" of the topographic features. New landslides have sharp features and often affect the vegetation and drainage patterns. With time, erosion subdues the topography, and the drainage and vegetation patterns become modified. The photos also show changes in the pattern of vegetation that are probably related to changes in surface and groundwater flow patterns.

Based upon our aerial photograph review, our review of topographic surveys by the USGS for the historic Scenic Drive Landslide, and our field reconnaissances and work on other projects within La Honda, we have identified eight generations of landslides ranging from prehistoric (labeled as No. 1 on Figure 3) to several historic landslides. The prehistoric landslides predate the development of the La Honda community and construction of the roadways in the area. The limits of the older landslides are less well defined than the younger. The landslide configurations are very complex because of the multiple episodes of landslide movement.

The oldest slide (No. 1) extends from the bases of the ridges surrounding the community of La Honda. The second oldest landslide (No. 2) lies entirely within Landslide No. 1 and is within the community of La Honda. Landslide No. 3 is a reactivation of a portion of Landslide No. 2. It has a coincident main scarp, but is narrower. More recent historical landsliding has occurred within the community and is generally confined within the limits of Landslide No. 3.

The subject site is located on the crest of a plunging spur-ridge outside the limits of these identified landslides.

3.3. Seismicity

Geologists and seismologists recognize the greater San Francisco Bay Area as one of the most active seismic regions in the United States. The seismicity in the region is related to activity within the San Andreas fault system, a major rift in the earth's crust that extends for at least 700 miles along the California Coast. Faults within this system are characterized predominantly by right-lateral, strike-slip movement. The four major faults that pass through the Bay Area in a northwest direction have produced approximately 12 earthquakes per century strong enough to cause structural damage. These major faults are the San Andreas, Hayward, Calaveras, and San Gregorio faults.

The site can be expected to experience periodic minor earthquakes or even a major earthquake (Moment magnitude 6.7 or greater) on one of the nearby active or potentially active faults during the design life of the proposed project. The Moment magnitude scale is directly related to the amount of energy released during an earthquake and provides a physically meaningful measure of the size of an earthquake event.

The U.S. Geological Survey (2015) estimates that by 2044, the probability of a Moment magnitude 6.0 earthquake occurring on one of the active faults in the San Francisco region is 98%. The probability of a Moment magnitude 6.7 or greater earthquake occurring on one of the active faults in the San Francisco region is 72%. The following table provides corresponding estimates for the probability of a major earthquake (Moment magnitude 6.7 or greater) for three major faults in the Bay Area.

Fault	Probability (%)
Hayward	14.3
Calaveras	7.4
San Andreas	6.4

30-Year Probability of Magnitude 6.7 or Greater Earthquake

The following table indicates the approximate distance and direction from the site to active and potentially active faults.

Fault	Approx. Distance To Fault	Direction From Site
La Honda	1¼ miles	Southwest
San Andreas	4 miles	Northeast
San Gregorio	6¼ miles	Southwest
Hayward	22¼ miles	Northeast
Calaveras	27 miles	Northeast

Regional Fault Distances and Directions

Because of the site's proximity to the San Andreas fault and the site's geology, maximum anticipated ground shaking intensities for the area are characterized as strong and equal to a Modified Mercalli (MM) intensity of between VII (Borcherdt, et al., 1975). An earthquake having a MM intensity of VII typically could cause slight to moderate damage to well built ordinary structures and considerable damage to poorly built or designed structures (Yanev, 1974) (see Table I, Modified Mercalli Scale of Earthquake Intensities).

The intensity of an earthquake differs from the Moment magnitude, in that intensity is a measure of the effects of an earthquake, rather than a measure of the energy released. These effects can vary considerably based on the earthquake magnitude, distance from the earthquake's epicenter, and site geology.

Since 1800, four major earthquakes have been recorded on the San Andreas fault. In 1836, an earthquake with an estimated maximum intensity of VII on the MM scale occurred east of the Monterey Bay on the San Andreas fault (Toppozada and Borcharadt, 1998). The estimated Moment magnitude (M_w) for this earthquake is about 6.25. In 1838, an earthquake occurred with an estimated intensity of about VIII-IX (MM), corresponding to a M_w of about 7.5. The San Francisco Earthquake of 1906 caused the most significant damage in the history of the Bay Area in terms of lives lost and cost of property damage. This earthquake created a surface rupture along the San Andreas fault from Shelter Cove to San Juan Bautista, about 290 miles in length. It had a maximum intensity of XI (MM), a M_w of about 7.9, and was felt as far away as Oregon, Nevada, and Los Angeles. The most recent earthquake to affect the Bay Area was the Loma Prieta earthquake of 17 October 1989, occurring in the Santa Cruz Mountains, which had a M_w of about 6.9. Ground shaking equal to an MM intensity of between VI and VII was felt at the site during the Loma Prieta Earthquake (Stover, et al., 1990).

In 1868 an earthquake with an estimated maximum MM intensity of X and M_w of about 7.0 occurred on the southern segment of the Hayward fault, between San Leandro and Fremont. In 1861, an earthquake of unknown magnitude (likely having an M_w of about 6.5) was reported on the Calaveras fault. The most recent significant earthquake on this fault was the 1984 Morgan Hill Earthquake, that had an M_w of about 6.2.

4. SITE CHARACTERIZATION

4.1. Regional Setting

We reviewed the aerial photographs and topographic maps for the site and vicinity. The irregularly shaped parcel is situated on the crest of an east-west trending, west-plunging spur ridge. The subject parcel is bounded on all sides by developed parcels within your ranch and is bordered to the north by Coggins Road.

4.2. Site Description

On 17 October 2016, our principal geologist performed a site reconnaissance. The updated partial site plan we developed is based upon a site plan prepared by David Mokhber Building Design that was provided to us by Mr. Ray Schmitt of Coastal Home Solutions, Inc., supplemented with geologic mapping from our prior study and recent our site observations (see Figure 4, Updated Partial Site Plan and Engineering Geologic Map). We generated a slope profile from this site plan, and used the profile to develop an updated geologic cross-section through the building site (see Figure 5, Updated Geologic Cross-Section A-A'). The site plan and profile are only as accurate as implied by the mapping technique used. The following is a summary of the surficial site characteristics.

The site and nearby parcels along the spur ridge are primarily accessed by Coggins Road that leads up from Woodland Vista Road. An unpaved shared private driveway provides access to the subject parcel and the adjacent developed properties to the east and west of the subject parcel. A short proposed driveway will extend south from the shared driveway and then turn west to provide access the proposed structures (see Figure 2). The topography across the crest of the spur ridge and in the area of the proposed improvements is relatively level to gently sloping, with slopes descending to the west and southwest with gradients between about 8:1 to 10:1 (horizontal to vertical). Beyond the north and northwest of the building pad area is a cut-slope with a gradient of about 2:1, associated with grading to create the shared driveway.

During our prior study, we observed a relatively small landslide on the slope descending from the north side of the shared driveway down to Coggins Road, north of the subject parcel (see Figure 4). The upper limit of the landslide is about 55 feet northwest of the closest corner of the proposed secondary dwelling and about 83 feet northeast of the nearest corner of the proposed residence and garage. Based on site topography and geomorphology, we judge this landslide to be shallow (less than 10 feet thick) and confined to the surficial soil and colluvium mantling the bedrock at the site

Site drainage within this area of the subject parcel is characterized as uncontrolled sheet-flow down the descending slopes from the ridge to the west, southwest, and north. At the time of our recent site visit, the ground surface within the area of the proposed improvements was vegetated with dry grasses.

4.3. Subsurface

As part of our prior study, we observed the excavation and logged several exploratory trenches on the subject parcel and adjoining parcels to the east and west. Trenches 1, 2, 3, and 9 were excavated within the area of the proposed improvements, and Trenches 4 and 5 were excavated within Coggins Road. The approximate locations of these trenches are shown on Figure 4, and the trench logs are provided in Appendix A. Our geologists/engineers logged the trenches in general accordance with the Unified Soil Classification System described in the Key To Logs also in Appendix A.

In general, the test trenches yielded a similar sequence of subsurface materials, including topsoil and colluvium (a soil material that is deposited from sheet flow runoff) underlain by weathered sandstone bedrock. The topsoil consists of firm to stiff, slightly moist, dark grayish brown, highly plastic silty clay that is about 1 to 2 feet thick. Beneath the topsoil in trenches 4 and 5, (within the area of the shared driveway), the exploration trenches revealed up to about 2 feet of moist, brown gravelly clay colluvium containing abundant sandstone fragments beneath the topsoil. Beneath the colluvium in Trench 5 and beneath the soil in trenches 1, 2, 3, and 9, the trenches exposed light gray, slightly mottled, massive, medium hard sandstone bedrock. The upper 4 feet of the bedrock in Trench 1 appeared to be deeply weathered to yellowish brown clayey silt with faint rock texture.

4.4. Groundwater

We did not encounter groundwater in any of the exploration trenches. It should be noted that fluctuations in the level of subsurface water could occur due to variations in rainfall, temperature, and other factors not evident at the time our observations were made.

4.5. Laboratory Testing

We previously performed laboratory testing as part of our evaluation of the geotechnical engineering properties of the soil and bedrock at the site. We retained soil and rock samples from the exploration trenches for laboratory classification and testing. The results of moisture content, dry density, shear strength, and plasticity index tests are provided in Appendix A. The plasticity index test performed on a sample of the colluvium retained from Trench 4 revealed the material to be highly expansive, with a plasticity index of 35.

5. LANDSLIDE SCREENING ANALYSES

As part of our study, we performed a qualitative screening analysis to evaluate the severity of the earthquake-induced landsliding hazard on the subject site and to determine if further analysis is warranted (CDMG, 1996). In accordance with Special Publication 117A by the California Geological Survey (2008), our screening analysis includes an evaluation of the following questions:

- ***Are existing landslides, active or inactive, present on, or adjacent (either uphill or downhill) to the project site?*** As described above, a shallow, small landslide was previously identified in the northern portion of the site, north of Coggins Road. Based on site geomorphology, we judge the landslide to be shallow and confined to surficial soil and colluvium mantling the bedrock. The shallow soil deformation is greater than 50 feet from any proposed structure. We observed no evidence of slope instability associated with bedrock materials along the crest of the ridge or site vicinity.

- ***Are there geologic formations or other earth materials located on or adjacent to the site that are known to be susceptible to landslides?*** According to the geologic map and our former subsurface exploration, Purisima formation sandstone bedrock underlies the subject site within the building area. This formation has not been found to be susceptible to deep-seated landsliding along this ridge.
- ***Do slope areas show surface manifestations of the presence of subsurface water (springs and seeps), or can potential pathways or sources of concentrated water infiltration be identified on or upslope of the site?*** Slope areas within and immediately around the building area are uniform and drainage courses are not disturbed. We did not observe any evidence of springs or seeps in areas that could affect the proposed ridge top building site.
- ***Are susceptible landforms and vulnerable locations present? These include steep slopes, colluvium-filled swales, cliffs or banks being undercut by stream or wave action, areas that have recently slid.*** The building site is on the crest of a gently plunging ridge. We have not identified susceptible landforms within the area of the proposed improvements.
- ***Given the proposed development, could anticipated changes in the surface and subsurface hydrology (due to watering of lawns, on-site sewage disposal, concentrated runoff from impervious surfaces, etc.) increase the potential for future landsliding in some areas?*** The current development concept will not increase the potential for landsliding on the subject site.

6. FINDINGS

Based upon the results of our study, it is our opinion that, from a geotechnical engineering perspective, the proposed residential development may proceed as planned, provided that the recommendations presented in this report are incorporated into the design and construction of the proposed improvements. In our opinion, the primary constraints to the proposed development include the potential for differential movement from soil creep or shrinking and swelling of the expansive surficial soils mantling the sandstone bedrock and the site's seismic setting.

6.1. Proposed Building Site

Our subsurface study revealed that the proposed building site is underlain at relatively shallow depths by supportive sandstone bedrock of the Purisima formation. The supportive bedrock is blanketed by up to about 2 or 3 feet of non-supportive soil and colluvium within the building area. Where located on moderate to steep slopes, these non-supportive materials can experience imperceptibly slow downhill creep under the force of gravity. Plasticity Index testing on the colluvium indicates the material is highly expansive. The underlying, supportive sandstone bedrock should provide adequate support for the foundations of a proposed residence and associated improvements.

6.2. Proposed Leachfield

A leachfield has been constructed along the ridgetop south and east of the proposed structures. Our prior subsurface study in this area revealed relatively shallow bedrock and no evidence of shallow groundwater. In our opinion, because of the gentle slope gradients, lack of shallow groundwater observed, and relatively shallow bedrock, it is in our opinion that the proposed leachfield will not have a significant impact on the stability of the slopes on the subject property and should not degrade the quality of the local groundwater. In addition, in our opinion, it is unlikely that effluent from the leachfield will surface. Furthermore, it is unlikely that effluent introduced into the subsurface soil will present a threat to the public health and safety or create a public nuisance. From a geotechnical engineering perspective, the proposed leachfield may be utilized as planned.

6.3. Slope Stability

Our study showed no evidence of landsliding on the property in the immediate vicinity of the proposed structures. However, as described above, a small, shallow landslide was identified on the north-facing slope north of the proposed improvements. Site topography and geomorphology suggest the feature is relatively shallow, and confined to the surficial topsoil and colluvium mantling the underlying bedrock. You should anticipate that this landslide may reactivate and move. Because of the distance between this feature and the proposed improvements, it is our opinion that continued movements of the landslide should not pose a significant hazard or have a direct impact on the integrity of the proposed improvements, provided the foundations are designed and constructed in accordance with the recommendations presented in this report.

Because of the gentle to moderately steep slopes and relatively thin layer of non-supportive soil and colluvium in the area of the proposed improvements, we judge the potential for a shallow landslide to develop within the building site to be low. Based upon our observations of the subsurface conditions and geologic setting of the site vicinity, it is our opinion that the potential for deep-seated landsliding is negligible.

The long-term stability of many hillside areas is difficult to predict. A hillside will remain stable only as long as the existing slope equilibrium is not disturbed by natural processes or by the acts of Man. Landslides can be activated by a number of natural processes, such as the loss of support at the bottom of a slope by stream erosion or the reduction of soil strength by an increase in groundwater level from excessive precipitation. Artificial processes caused by Man include improper grading activities, the introduction of excess water through excessive irrigation, improperly designed or constructed leachfields, and poorly controlled surface runoff.

Although our knowledge of the causes and mechanisms of landslides has greatly increased in recent years, it is not yet possible to predict with certainty exactly when and where all landslides will occur. At some time over the span of thousands of years, most hillsides will experience landslide movement as mountains are reduced to plains. Therefore, a small but unknown level of risk is always present to structures located in hilly terrain. Owners of property located in these areas must be aware of, and willing to accept, this unknown level of risk.

6.4. Seismicity

Our reconnaissance and review of published geologic maps and aerial photographs revealed that no known active or potentially active faults pass through the subject property. However, it is reasonable to assume that the site will be subjected to strong ground shaking from a major earthquake on at least one of the nearby active faults during the design life of future improvements (Borcherdt et al., 1975). During such an earthquake, it is our opinion that the danger from fault offset through the site is negligible.

7. RECOMMENDATIONS

Because the proposed project is still in a relatively early phase of development, it is conceivable that changes and additions will be made to the proposed development concept following submission of this report. We recommend that as various changes and additions are made, you contact us to evaluate the geotechnical aspects of these modifications.

As currently planned, a single-story manufactured home with a two-car garage, and a detached manufactured secondary dwelling within the northern central portion of the parcel. A gravel driveway will provide access to the structures from the shared driveway. The following recommendations must be incorporated into all aspects of future development.

7.1. Location of Proposed Improvements

The proposed improvements must be confined to the approximate building area shown on Figure 4. Do not construct improvements outside of this generalized area without written approval from C2. If other structures are planned in the future, we must evaluate their location to provide appropriate geotechnical engineering design criteria.

7.2. Seismic Design Criteria

We recommend that the project structural design engineer provide appropriate seismic design criteria for proposed foundations and associated improvements. The following information is intended to aid the project structural design engineer to this end and is based on criteria set forth in the 2013 California Building Code (CBC). The mapped spectral accelerations and site coefficients were computed using the USGS Seismic Design Maps tool with the 2010 ASCE 7 design code reference (updated 2013).

Design Parameters

$$\begin{aligned}\text{Latitude} &= 37.31518^\circ \\ \text{Longitude} &= -122.26113^\circ \\ \text{Site Class} &= C \\ S_s &= 1.689 \quad S_1 = 0.779 \\ F_a &= 1.0 \quad F_v = 1.3\end{aligned}$$

Experience has shown that earthquake-related distress to structures can be substantially mitigated by quality construction. We recommend that a qualified and reputable contractor and skilled craftsmen build the associated improvements. We also recommend that the project structural design engineer and project architect monitor the construction to make sure that their designs and recommendations are properly interpreted and constructed.

7.3. **Earthwork**

At the time of this study, the full extent of any proposed earthwork had not been finalized. We anticipate that a minor amount of grading may be required to construct the building pads, proposed gravel driveway, and utility trenches. Any proposed earthwork should be performed in accordance with the recommendations provided below.

7.3.1. **Clearing and Site Preparation**

- Clear all obstructions, including brush, trees not designated to remain, and debris on any areas to be graded.
- Clear and backfill any holes or depressions resulting from the removal of underground obstructions below proposed finished subgrade levels with suitable material compacted to the requirements for engineered fill given below.
- After clearing, strip the site to a sufficient depth to remove all surface vegetation and organic-laden topsoil. At the time of our field study, we estimated that a stripping depth of approximately 3 inches would be required on natural slope areas. This material must not be used as engineered fill; however, it may be used for landscaping purposes.

7.3.2. **Fill Material**

- Based on our study, it is our opinion that the bedrock materials encountered in the exploration trenches should be suitable for use as fill. On-site surficial soil or colluvium should not be used for engineered fill, but may be used for landscaping purposes. On-site or imported materials must meet the requirements specified below to be used as engineered fill:
 - 1) have an organic content less than 3% by volume;
 - 2) no rocks or lumps greater than 6 inches in maximum dimension, and
 - 3) no more than 15% of the fill may be greater than 2½ inches in maximum dimension.
- In addition to the requirements above, any import fill must have a plasticity index (PI) of 15% or less.
- **Contact C2 with samples of proposed fill materials at least four days prior to fill placement for laboratory testing and evaluation.**

7.3.3. Keyways and Benches

- Fill placed on slopes in excess of 5:1 must be keyed and benched into the underlying supportive material / bedrock to provide a firm, stable surface for support of the fill.
- A keyway, located at the toe of proposed fill, must be excavated a minimum of 3 feet into the underlying bedrock, as measured on the downhill side of the keyway.
- Keyways and benches generally must be a minimum of 5 feet wide and must be excavated entirely into the supportive material.
- Temporary back slopes may be vertically excavated provided they are constructed in the dry season and meet Cal OSHA requirements.
- Both the keyway and any required benches must be excavated near level in the direction parallel to the natural slope and must be provided with an approximately 2% gradient sloping into the hillside to provide resistance to lateral movement and to facilitate proper subdrainage.
- **Contact C2 to evaluate the actual location, size, and depth of the required keyway and benches at the time of construction.**

7.3.4. Subdrains

- C2 must determine the need for subdrains at the time of construction.
- In general, fill exceeding 5 feet deep should be provided with subdrains.
- Subdrains must consist of a 4-inch diameter, rigid, heavy-duty, perforated pipe (Schedule 40, SDR 21, or equivalent), approved by C2, embedded in drainrock (crushed rock or gravel).
- Flexible corrugated pipe must not be used.
- The pipe must be placed with the perforations down on a 2- to 3-inch bed of drainrock. The drainrock must be separated from the fill and the native material by a geotextile filter fabric, approved by C2.
- Subdrain pipes must be provided with clean-out risers at their up-gradient ends and at all sharp changes in direction.
- Changes in pipe direction must be made with "sweep" elbows to facilitate future inspection and clean-out.
- Subdrain systems must be provided with a minimum 1% gradient and must discharge onto an energy dissipater at an appropriate downhill location approved by C2.

7.3.5. Compaction Procedures

- Prior to fill placement, scarify the surface to receive the fill to a depth of 6 inches.
- Moisture condition the imported fill to the materials' approximate optimum moisture content.
- Spread and compact the fill in lifts not exceeding 8 inches in loose thickness.
- Compact the fill to at least 90% relative compaction by the Modified Proctor Test method, in general accordance with the ASTM Test Designation D1557 (latest revision).
- **Contact C2 to observe the placement and test the compaction of engineered fill.** Provide at least two working days notice prior to placing fill.

7.3.6. Permanent Slopes

- Construct the gradients of cut or fill slopes to no steeper than 2:1.
- Re-vegetate all graded surfaces or areas of disturbed ground prior to the onset of the rainy season following construction to control soil erosion.
- Install other erosion control provisions if vegetation is not established by the rainy season.
- Maintain ground cover vegetation once it is established to provide long-term erosion control.

7.3.7. Trench Backfill

- Backfill all utility trenches with compacted engineered fill.
- Place suitable on-site soil into the trenches in lifts not exceeding 8 inches in uncompacted thickness, and compact it to at least 90% relative compaction by mechanical means only.
- If imported sand is used, compact it to at least 90% relative compaction. Do not use water jetting to obtain the minimum degree of compaction in imported sand backfill. If the trench is greater than 50 feet long, located on sloping ground greater than 5:1 (horizontal to vertical), and is backfilled with sand, check dams should be installed to reduce the potential of the sand washing out.
- Compact the upper 6 inches of trench backfill to at least 95% relative compaction in all pavement areas.
- **Contact C2 to observe and test compaction of the fill.**

7.4. Foundations

Because of the presence of shallow bedrock in the area of the proposed structures, we recommend that they be supported on conventional spread footings gaining support in the underlying bedrock. We recommend that your engineer design and your contractor construct the proposed foundation elements in accordance with the following recommendations.

7.4.1. **Spread Footings**

- Embed spread footings a minimum of 12 inches into the underlying supportive bedrock below the plane at which there is a minimum of 5 feet horizontal separation between the downhill face of the footing and the surface of the bedrock. It should be anticipated that footings excavated at native site grades within the building area may need to be 2 to 5 feet deep in total depth to achieve the 12 inches of embedment into the bedrock.
- Design the spread footings supported in the bedrock for an allowable bearing pressure of 3,000 psf for dead plus live loads, with a 1/3 increase for transient loads, including wind and seismic.
- All footings adjacent to utility trenches must have their bearing surface below an imaginary plane projected upward from the bottom edge of the trench at a 1:1 (horizontal to vertical) slope.
- Lateral loads may be resisted by friction between the foundation bottoms and the supporting subgrade using a friction coefficient of 0.35.
- As an alternative, a passive pressure equal to an equivalent fluid weight of 350 pcf may be used for footings poured neat in excavations into the bedrock below the plane at which there is a minimum of 5 feet horizontal separation between the downhill face of the footing and the surface of the bedrock.
- Use either passive pressure or the friction coefficient to design for lateral loading. Lateral loads resistance must not combine the use of the friction coefficient and passive pressure.
- The structural design engineer must determine concrete reinforcing; but, as a minimum, all continuous footings must be provided with at least two No. 4 steel reinforcing bars, one placed at the top and one placed at the bottom of the footing, to provide structural continuity and to permit the spanning of any local irregularities.
- Design for differential and total settlement for footings founded in supportive material of less than 1 inch.
- Clear the bottoms of the footing excavations of loose cuttings and soil fall-in prior to the placement of concrete.
- **Contact C2 to observe the footing excavations prior to placing reinforcing steel** to evaluate depth into supportive material.

7.4.2. Flatwork

We anticipate that the driveway will be unpaved and covered with gravel; however, we also anticipate that concrete slab-on-grade may be used for the garage floor and for porches and walkways. Where located on the expansive surficial topsoil and colluvium, the overlaying flatwork will be subject to differential movement. We believe this condition will result in minor ongoing cosmetic damage to the flatwork. To mitigate the risk of differential movement of the flatwork, we recommend the following options:

- Option 1: Construct the flatwork using a flexible pavement system that can accommodate differential movement, such as pavers.
- Option 2: Remove and replace the upper 24 inches of the topsoil and colluvium with engineered fill in accordance with the earthwork recommendation provided above.

For concrete slabs-on-grade we recommend the following minimum requirements:

- Support concrete slabs-on-grade on a minimum of 6 inches of non-expansive fill, where supportive bedrock is encountered, or 24 inches of non-expansive fill, where expansive soil is encountered,
- Place non-expansive fill to the requirements for compacted fill given above.
- Proof-roll the surface of the non-expansive fill to provide a smooth, firm surface for slab support prior to placement of reinforcing steel.
- Design slab reinforcement in accordance with anticipated use and loading, but at a minimum, reinforce slabs with No. 3 rebar on 18-inch centers each way, placed mid-height in the slab.
- Support the reinforcing from below on concrete blocks (or similar) during concrete pouring to make sure that it remains mid-height in the slab.
- Place grooves in the concrete slabs at 10-foot intervals or in accordance with the structural design engineer's recommendations to help control cracking.

Where floor wetness is undesirable:

- The building designer or qualified waterproofing consultant must provide moisture barrier requirements.
- The following recommendations are typical moisture barrier standards. We do not guarantee that these measures will prevent all future moisture intrusion. If necessary, you should consult a qualified waterproofing consultant to provide waterproofing design.

- Traditionally, designers have specified the following: place 4 inches of free-draining gravel beneath the floor slab to serve as a capillary barrier between the subgrade soil and the slab. Following gravel placement, place a heavy-duty membrane over the gravel in order to minimize vapor transmission and then place 2 inches of sand over the membrane to protect it during construction. Just prior to placing concrete, lightly moisten the sand.
- More recent standards suggest using a puncture resistant, heavy-duty membrane (such as a minimum of 15 mil Stego Wrap, or equivalent) in direct contact with the floor slab and underlain by 6 inches of free-draining gravel.
- The structural designer must evaluate moisture conditions related to concrete slab curing and performance. The builder must provide appropriate drying time as determined by the designer.
- Use the gravel, heavy-duty membrane, and/or sand (if specified) in lieu of the upper 6 inches of recommended non-expansive fill.

7.5. Drainage

Control of surface drainage is critical to the successful performance of the proposed improvements. The results of improperly controlled runoff may include foundation heave and/or settlement, erosion, gulying, ponding, and potential shallow slope instability. To mitigate the risk of improperly controlled runoff, we recommend that you implement the following:

- Prevent surface water from ponding in areas adjacent to the foundation of the proposed structures by grading adjacent areas to create proper drainage by sloping them away from the structures.
- As an alternative, install area drains to collect surface runoff.
- Provide roof gutters with downspouts on the structures.
- Do not allow water collected in the gutters to discharge freely onto the ground surface adjacent to the foundation.
- Convey water from downspouts and/or area drains away from the residence via buried, closed conduits or lined surfaces.
- Discharge collected water in an appropriate manner and at an appropriate location approved by C2. Do not locate the discharge on, or adjacent to, steep, potentially unstable terrain.
- Use buried conduits consisting of rigid, smooth-walled pipes (PVC). **Do not use flex-pipes.**
- Provide downspouts with slip-joint connectors or clean-outs, where they are connected to buried pipes, to facilitate maintenance (see Figure 6, Conceptual Downspout Clean-Out Diagram).

- Convey all collected water away from the structures via buried, closed conduit or hard surfaced drainage way, and discharge onto an energy dissipater at an appropriate downslope location approved by C2. Energy dissipaters may consist of a short "T" fitting placed in a shallow trench and covered with a mound of cobbles (see Figure 7, Conceptual Energy Dissipater Diagram). The discharge must not be located on, or adjacent to, steep, potentially unstable terrain or where runoff will adversely impact adjacent parcels.
- Perform annual maintenance of the surface drainage systems, including:
 - 1) inspecting and testing roof gutters and downspouts to make sure that they are in good working order and do not leak;
 - 2) inspecting and flushing area drains to make sure that they are free of debris and are in good working order; and
 - 3) inspecting surface drainage outfall locations to verify that introduced water flows freely through the discharge pipes and that no excessive erosion has occurred.
- Contact C2 if erosion is detected so that we may evaluate its extent and provide mitigation recommendations, if needed.

8. PLAN REVIEW AND CONSTRUCTION OBSERVATION

We must be retained to review the final grading, foundation, and drainage control plans in order to assess whether that our recommendations have been properly incorporated into the proposed project. **WE MUST BE GIVEN AT LEAST ONE WEEK TO REVIEW THE PLANS AND PREPARE A PLAN REVIEW LETTER.**

We must also be retained to observe the grading and the installation of foundations and drainage systems in order to:

- assess whether the actual soil conditions are similar to those encountered in our study;
- provide us with the opportunity to modify the foundation design, if variations in conditions are encountered; and
- observe whether the recommendations of our report are followed during construction.

Sufficient notification prior to the start of construction is essential, in order to allow for the scheduling of personnel to insure proper monitoring.

WE MUST BE NOTIFIED AT LEAST TWO WEEKS PRIOR TO THE ANTICIPATED START-UP DATE. IN ADDITION, WE MUST BE GIVEN AT LEAST TWO WORKING DAYS NOTICE PRIOR TO THE START OF ANY ASPECTS OF CONSTRUCTION THAT WE MUST OBSERVE.

The phases of construction that we must observe include, but are not necessarily limited to, the following.

1. **EARTHWORK:** During construction to observe keyway and bench excavations, evaluate the need for subdrainage, and to test compaction of engineered fill
2. **FOOTING EXCAVATION:** Prior to placement of reinforcing steel to evaluate depth to supportive material
3. **SLABS-ON-GRADE:** Prior to and during placement of non-expansive fill to observe the subgrade preparation and to test compaction of non-expansive fill
4. **SURFACE DRAINAGE SYSTEMS:** Near completion to evaluate installation and discharge locations

* * * * *

A Bibliography, a List of Aerial Photographs, and the following Figures, Table, and Appendix are attached and complete this report.

BIBLIOGRAPHY

AMERICAN SOCIETY OF CIVIL ENGINEERS, 2002, Recommended Procedures for Implementation of DMG Special Publication 117 Guidelines for Analyzing and Mitigating Landslide Hazards in California, June 2002.

BORCHERDT, R. D., J. F. GIBBS, and K. R. LAJOIE, 1975, Maps Showing Maximum Earthquake Intensity Predicted in the Southern San Francisco Bay Region, California, for Large Earthquakes on the San Andreas and Hayward Faults, U.S. Geological Survey, Miscellaneous Field Studies Map MF-709.

BRABB, E. E., R. W. GRAYMER, AND D. L. JONES, 1998, Geology of the Onshore Part of San Mateo County, California: Derived from the Digital Database Open-File 98-137, U. S. Geological Survey, 1:62,500.

CALIFORNIA BUILDING STANDARDS COMMISSION, 2013 California Building Code, California Code of Regulations, Title 24, Part 2, Volume 2 of 2.

CALIFORNIA DEPARTMENT OF CONSERVATION DIVISION OF MINES AND GEOLOGY and U. S. GEOLOGICAL SURVEY, 1996, Probabilistic Seismic Hazard Assessment for the State of California, CDMG Open File Report 96-08 and USGS Open File Report 96-706.

CALIFORNIA GEOLOGICAL SURVEY, 2008, Guidelines for Evaluating and Mitigating Seismic Hazards in California, California Department of Conservation, Division of Mines and Geology, Special Publication 117A.

HUNT, R.E., 2005, Geotechnical Engineering Investigation Handbook, CRC Press, Boca Raton, Florida.

SOUTHERN CALIFORNIA EARTHQUAKE CENTER, 1999, Recommended Procedures for the Implementation of DMG Special Publication 117, Guidelines for Analyzing and Mitigating Liquefaction Hazards in California, University of Southern California, March 1999.

STOVER, C. W., B. G. REAGOR, F. W. BALDWIN, and L. R. BREWER, 1990, Preliminary Iseismal Map for the Santa Cruz (Loma Prieta), California, Earthquake of October 17, 1989, U. S. Geological Survey, Open-File Report 90-18.

TOPPOZADA, T. R. and BORCHARDT, G., 1998, Re-evaluation of the 1836 "Hayward Fault" and the 1838 San Andreas Fault Earthquakes, Bulletin of Seismological Society of America, 29(1).

UPP GEOTECHNOLOGY, INC, 1988, Geotechnical Investigation, 3 Adjoining Single Family Homesites, Lands of Coggins Woodland Vista, San Mateo County, California, unpublished consultant's report.

U. S. GEOLOGICAL SURVEY, 2013, U.S. Seismic Design Maps, tool based upon 2010 ASCE 7, updated April 2013, URL: <http://geohazards.usgs.gov/designmaps/us/application.php>.

U. S. GEOLOGICAL SURVEY, 2015, UCERF3: A New Earthquake Forecast for California's Complex Fault System, U.S. Geological Survey Fact Sheet – 2015-3009.

YANEV, P., 1974, Peace of Mind in Earthquake Country: Chronicle Books, San Francisco, California.

LIST OF AERIAL PHOTOGRAPHS

FAIRCHILD AERIAL SURVEY, black and white, dated April 12, 1941, at a scale of 1:24,000, Serial Nos. 6600-458 and 459

U.S. GEOLOGICAL SURVEY, black and white, dated October 13, 1963, at a scale of 1:10,600, Serial Nos. DDB-3DP-52 and 53

BAY AREA TRANSPORTATION STUDY, black and white, dated May 12, 1965, at a scale of 1:24,000, Serial Nos. 3-53, 54, and 55

U.S. GEOLOGICAL SURVEY, dated August 16, 1982, at a scale of 1:60,000, Serial Nos. HAP 82-F 261-90 and 91; IR

U.S. GEOLOGICAL SURVEY, dated June 22, 1987, at a scale of 1:18,000, Serial Nos. Wild 15/4 UAG 2791 511-53 and 54; IR

U.S. GEOLOGICAL SURVEY, color, dated August 8, 1995, at a scale of 1:24,000, Serial Nos. KAV 4905 6-13 and 14

FIGURES AND TABLE

FIGURE NO.

SITE LOCATION MAP..... 1

REGIONAL GEOLOGIC MAP..... 2

LA HONDA LANDSLIDE MAP..... 3

UPDATED PARTIAL SITE PLAN AND ENGINEERING GEOLOGIC MAP..... 4

UPDATED GEOLOGIC CROSS-SECTION A-A' 5

CONCEPTUAL DOWNSPOUT CLEAN-OUT DIAGRAM..... 6

CONCEPTUAL ENERGY DISSIPATER DIAGRAM..... 7

TABLE NO.

MODIFIED MERCALLI SCALE OF EARTHQUAKE INTENSITIES..... I

TABLE NO.

KEY TO LOGS, LOGS OF PRIOR EXPLORATION TRENCHES, AND
AND LABORATORY TEST DATA..... A

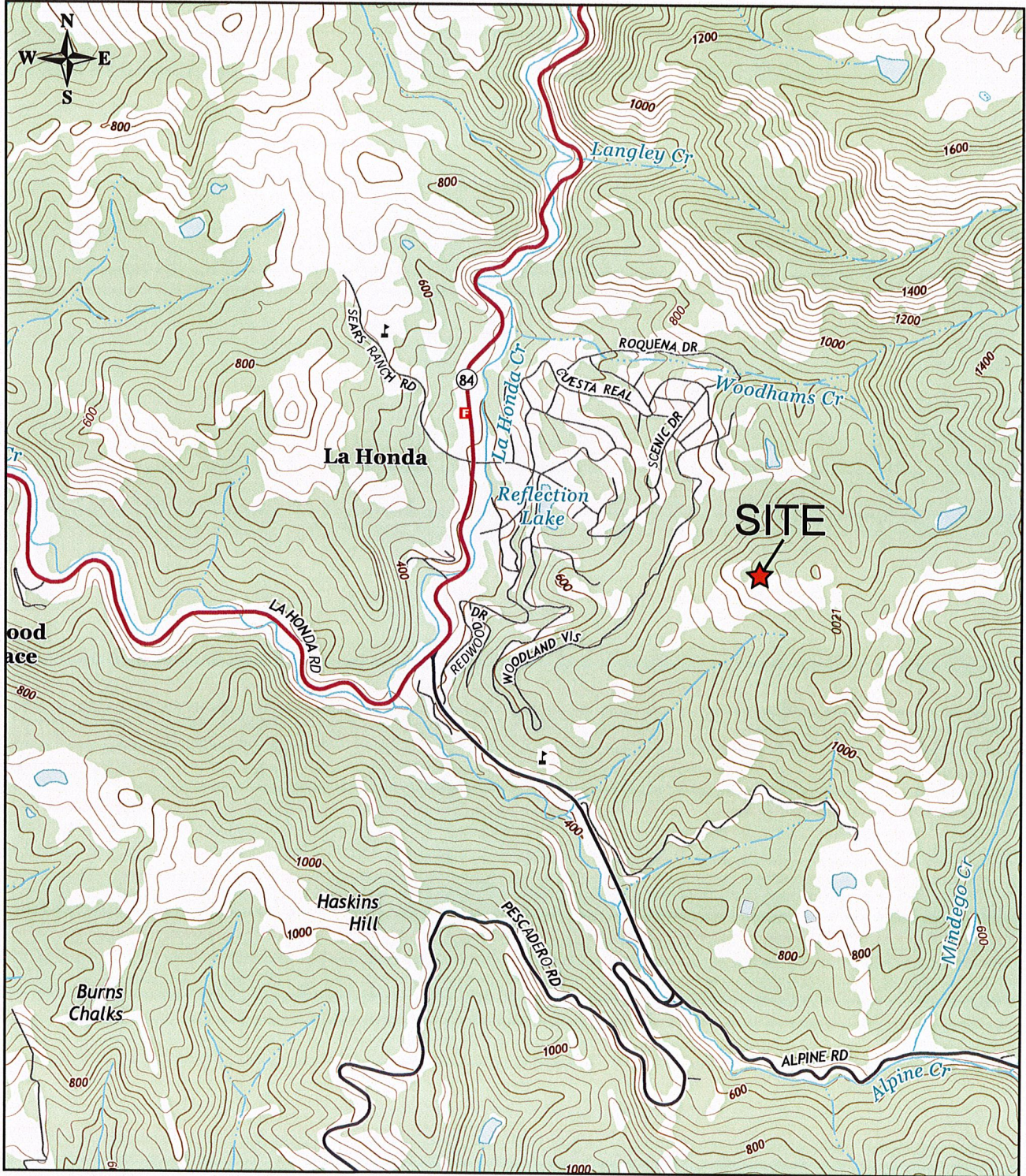

BASE: The National Map US Topo; UNITED STATES GEOLOGICAL SURVEY; 2015

SITE LOCATION MAP

UPP GEOTECHNOLOGY

a division of **C2EARTH, INC.**

COGGINS PROPERTY
 APN 083-310-150
 San Mateo County, California

DRAFTED/REVIEWED

SCALE

DOCUMENT ID.

DATE

JB/CH

1" = 2,000'

00514U-02R1

November 2016

Figure 1

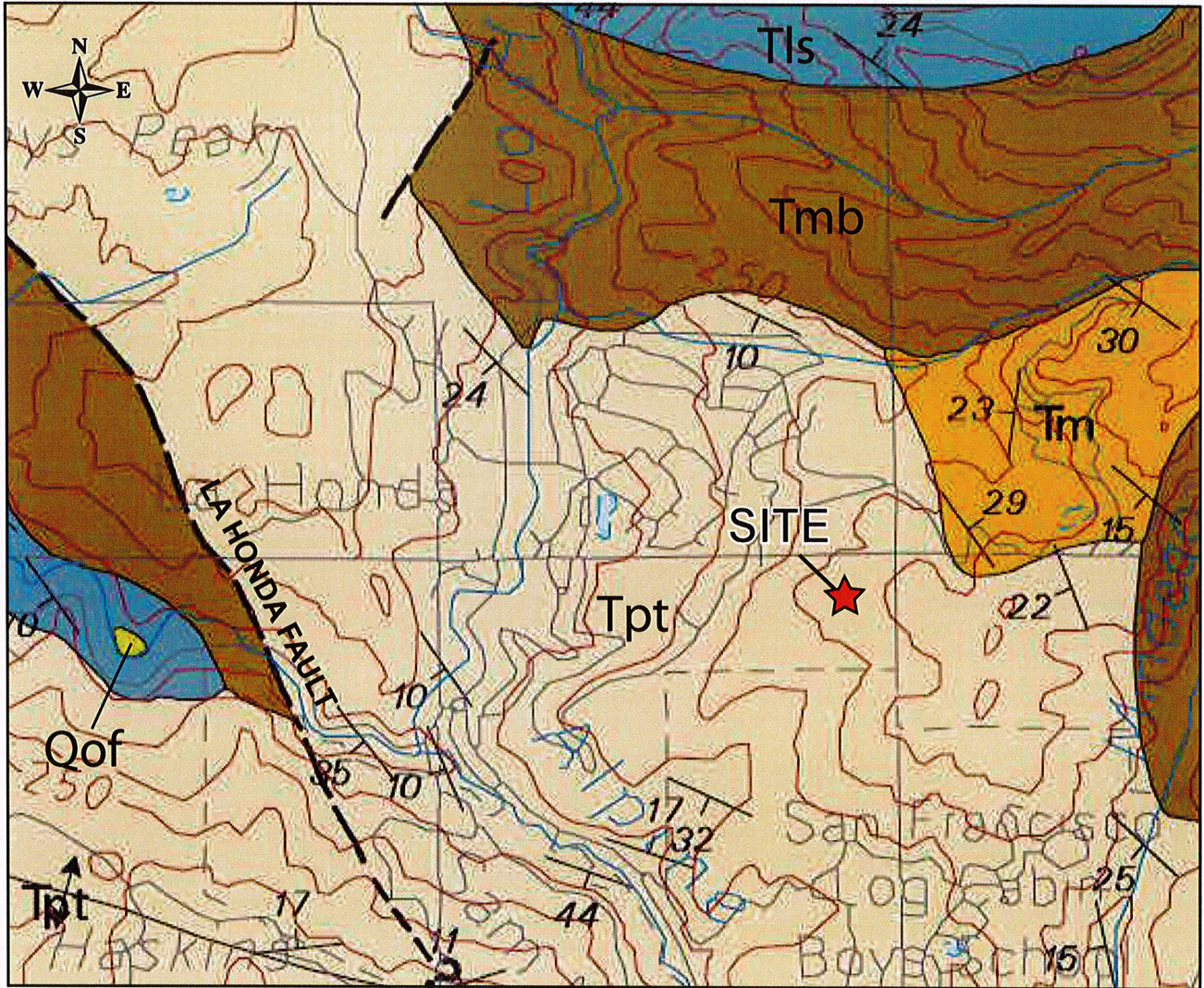

EXPLANATION

Qof - Alluvial Fan Deposits
 Tpt - Purisma Formation
 Tm - Monterey Formation
 Tls - Lambert Shale
 Tmb - Mindego Basalt



Strike and Dip

Geologic Contact

Anticline



Fault

dashed where approximate
 and dotted where concealed

BASE: Geology of the Onshore Part of San Mateo County, California:
 A Digital Database Open-File 98-137; BRABB, et al.; 1998

REGIONAL GEOLOGIC MAP

UPP GEOTECHNOLOGY

a division of **C2EARTH, INC.**

COGGINS PROPERTY
 APN 083-310-150
 San Mateo County, California

DRAFTED/REVIEWED

SCALE

DOCUMENT ID.

DATE

JB/CH

1" = 2,000'



00514U-02R1

November 2016

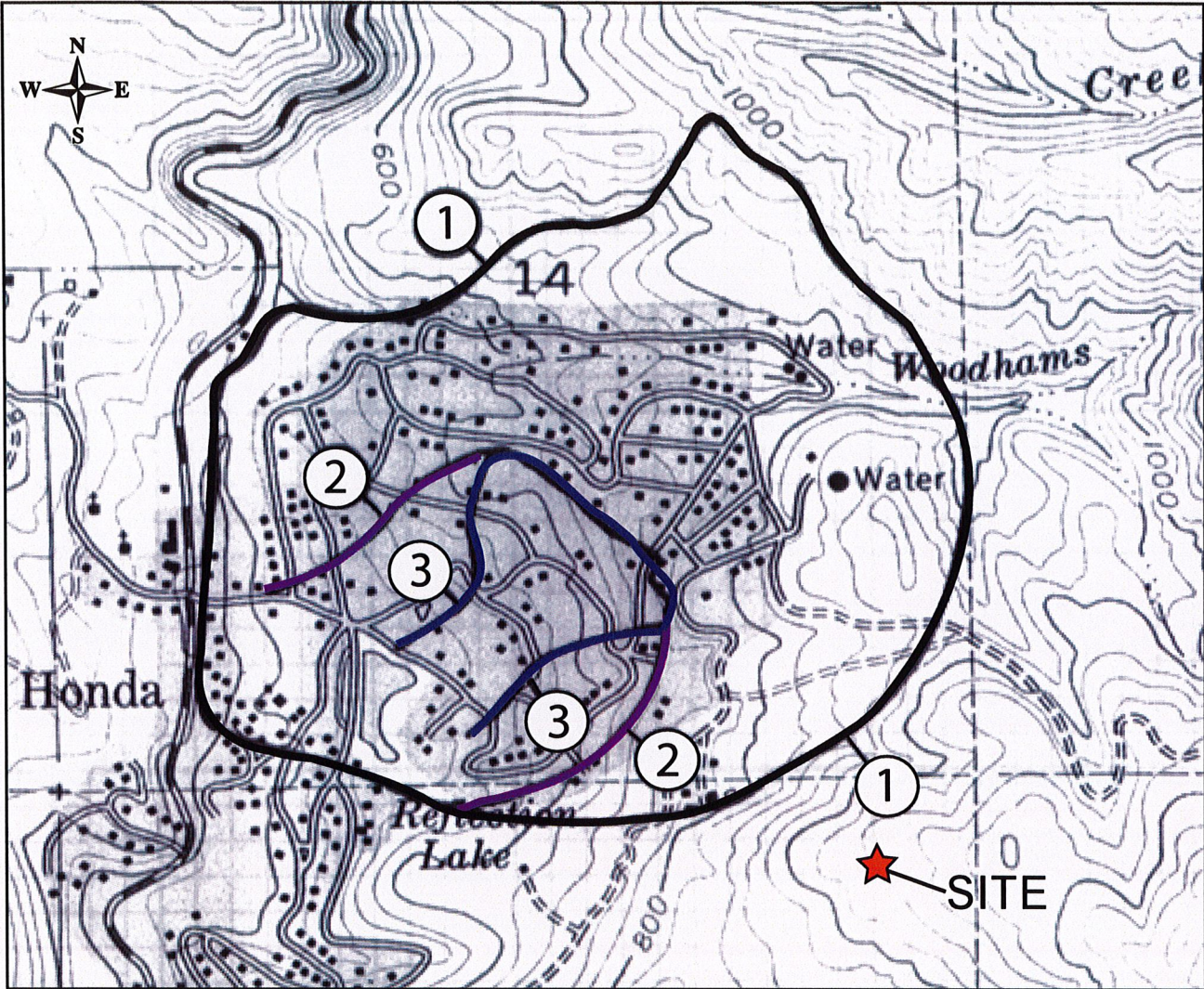
Figure 2



EXPLANATION

-  ③ Prehistoric Landslide
-  ② Prehistoric Landslide
-  ① Prehistoric Landslide (Oldest)

BASE: USGS; La Honda Quadrangle; 1968

LA HONDA LANDSLIDE MAP

UPP GEOTECHNOLOGY

a division of **C2EARTH, INC.**

COGGINS PROPERTY
 APN 083-310-150
 San Mateo County, California

DRAFTED/REVIEWED	SCALE	DOCUMENT ID.	DATE	Figure 3
JB/CH	1" = 1,000'	00514U-02R1	November 2016	

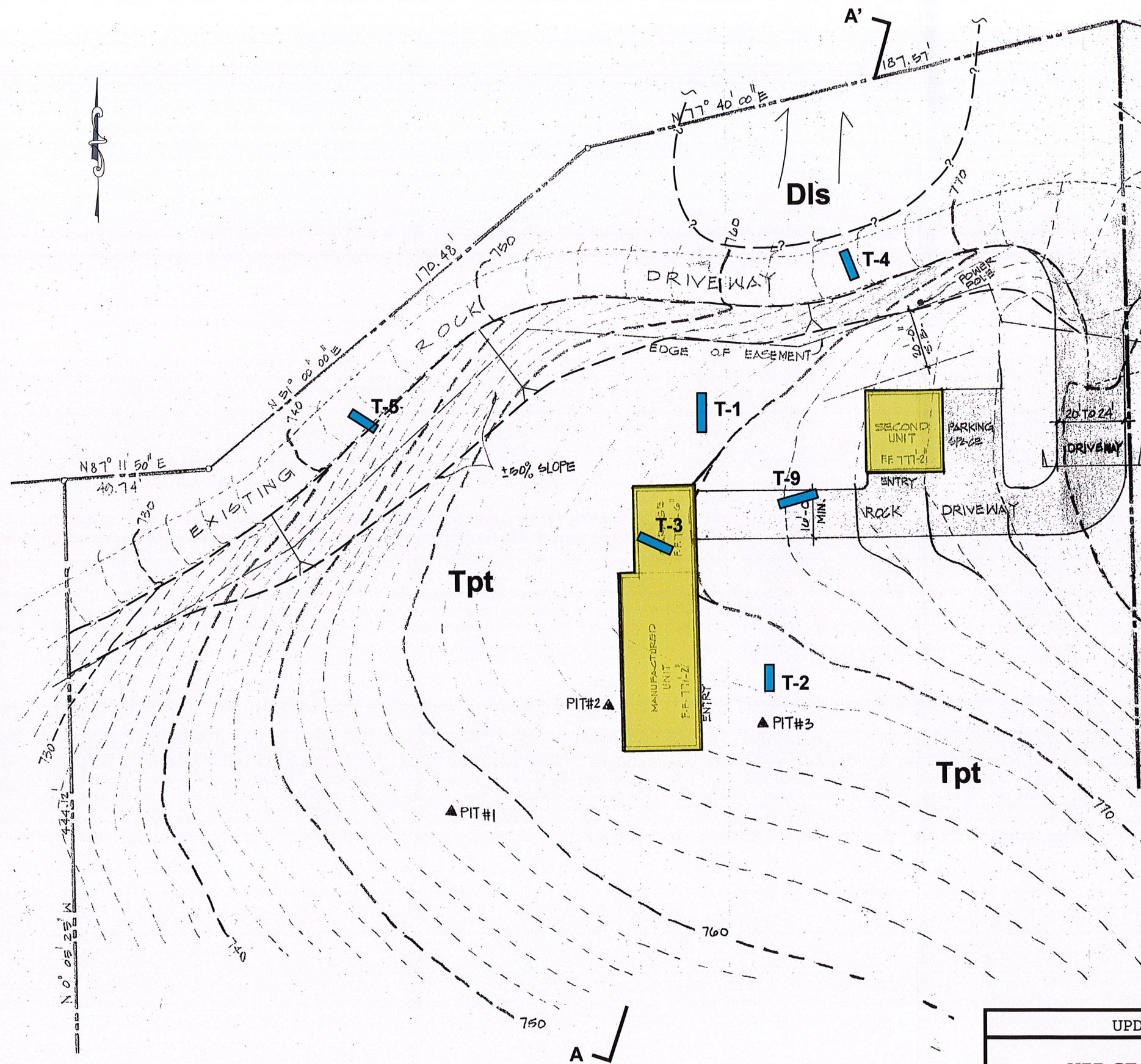

EXPLANATION

- Dis** - Dormant Landslide Deposits
arrows indicate general direction of movement
- Tpt** - Purisima Formation
- Cut Slope
- T-5** - 1988 Exploration Trench Location and Number
- Geologic Cross-Section Location
- Proposed Structures

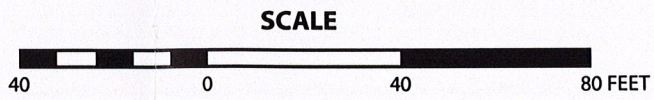

NOTE: This plan is a conceptual illustration of observed geotechnical and geologic features and should not be used for any other purpose.

BASE: Site Plan; Sheet 1; DAVID MOKHBER BUILDING DESIGN

UPDATED PARTIAL SITE PLAN AND ENGINEERING GEOLOGIC MAP				
UPP GEOTECHNOLOGY a division of C2EARTH, INC.		COGGINS PROPERTY APN 083-310-150 San Mateo County, California		
DRAFTED/REVIEWED	SCALE	DOCUMENT ID.	DATE	Figure 4
JB/CH	As Shown	00514U-02R1	November 2016	

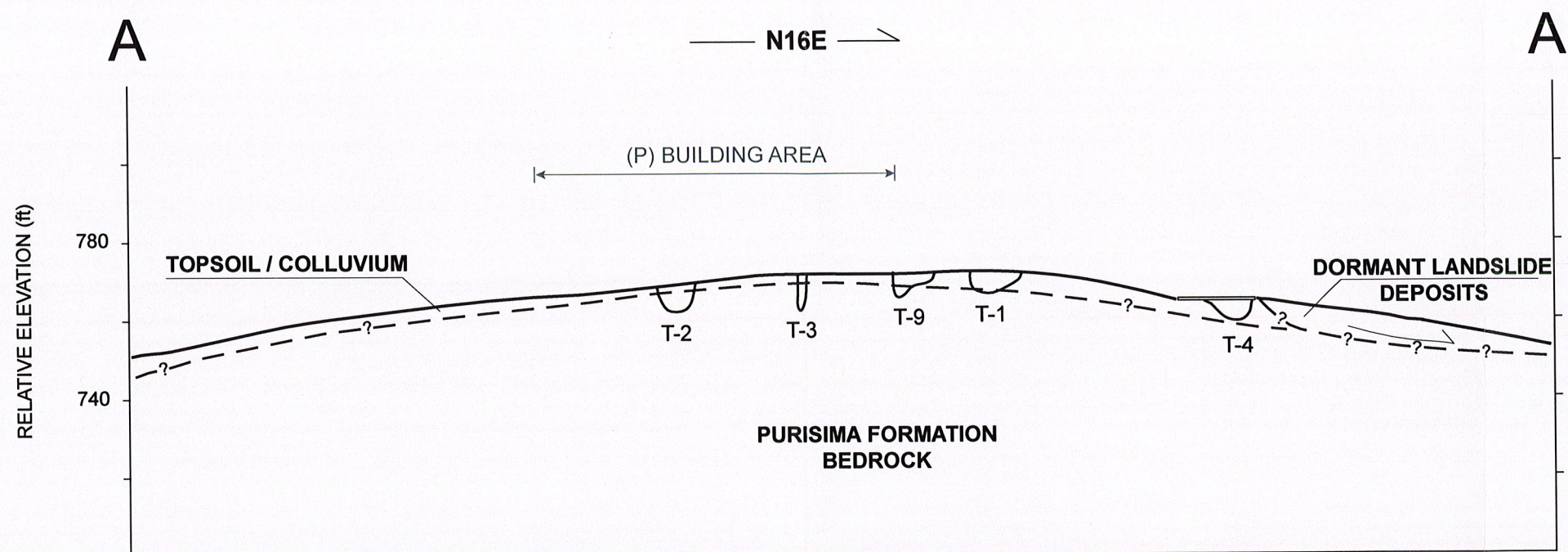

NOTE: This cross-section is a conceptual illustration of general geologic relationships and should not be used for any other purpose.

BASE: Site Plan; Sheet 1; DAVID MOKHBER BUILDING DESIGN

UPDATED GEOLOGIC CROSS-SECTION A-A'				
UPP GEOTECHNOLOGY a division of C2EARTH, INC.		COGGINS PROPERTY APN 083-310-150 San Mateo County, California		
DRAFTED/REVIEWED	SCALE	DOCUMENT ID.	DATE	Figure 5
JB/CH	1" = 40'	00514U-02R1	November 2016	

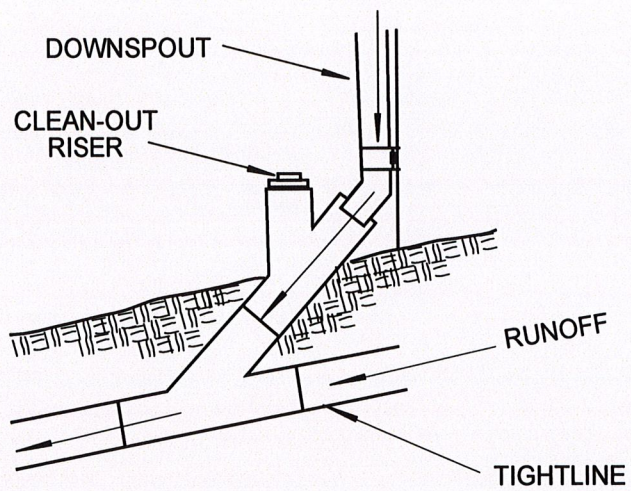

CONCEPTUAL DOWNSPOUT CLEAN-OUT DIAGRAM

UPP GEOTECHNOLOGY

a division of **C2EARTH, INC.**

COGGINS PROPERTY
 APN 083-310-150
 San Mateo County, California

DRAFTED/REVIEWED	SCALE	DOCUMENT ID.	DATE	Figure 6
JB/CH	Not Applicable	00514U-02R1	November 2016	

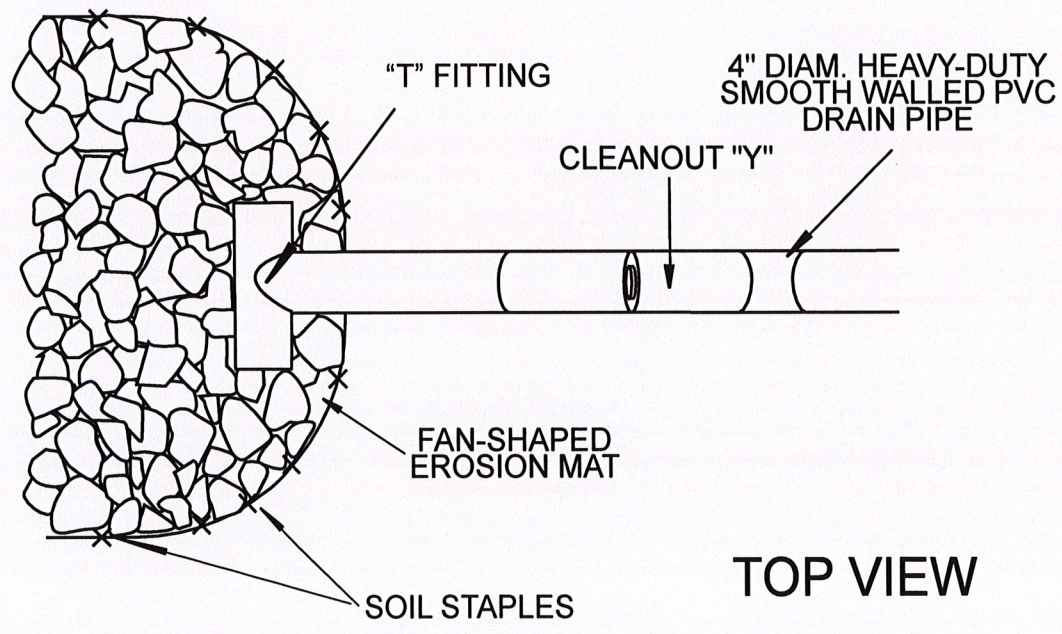
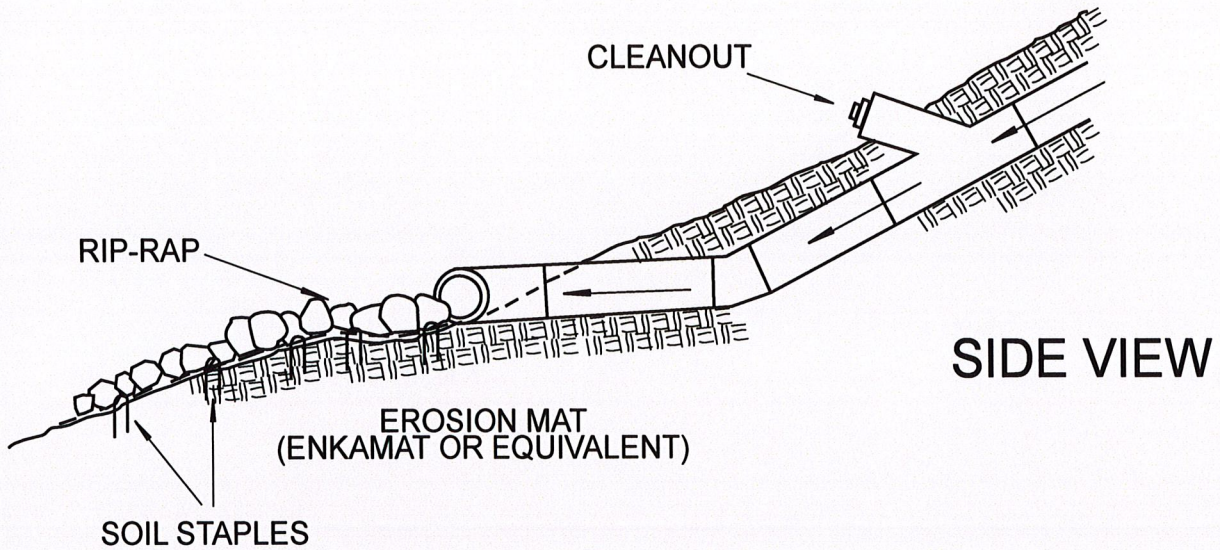

CONCEPTUAL ENERGY DISSIPATER DIAGRAM

UPP GEOTECHNOLOGY
a division of **C2EARTH, INC.**

COGGINS PROPERTY
APN 083-310-150
San Mateo County, California

DRAFTED/REVIEWED	SCALE	DOCUMENT ID.	DATE	Figure 7
JB/CH	Not Applicable	00514U-02R1	November 2016	

APPLICATION TO USE

NOTE: THIS APPLICATION FOR AUTHORIZATION TO USE THIS COPYRIGHTED DOCUMENT MUST BE COMPLETED FOR USE OR COPYING OF THE FOLLOWING DOCUMENT BY ANYONE OTHER THAN THE CLIENT.

UPDATE GEOLOGIC AND GEOTECHNICAL STUDY
PROPOSED RESIDENTIAL DEVELOPMENT

COGGINS PROPERTY
APN 083-310-150
SAN MATEO COUNTY, CALIFORNIA

Document Id. 00514U-02R1
Dated 28 November 2016

TO: Upp Geotechnology
a division of C2Earth, Inc.
750 Camden Avenue, Suite A
Campbell, CA 95008

FROM: _____

Please clearly identify name and address of person/entity applying to use or copy this document.

APPLICANT: _____ hereby applies for permission to use the above referenced document for the following purpose(s):

Applicant understands and agrees that the document listed above is a copyrighted document, that Upp Geotechnology, a division of C2Earth, Inc. is the copyright owner and that unauthorized use or copying of the document is strictly prohibited without the express written permission of Upp Geotechnology. Applicant understands that Upp Geotechnology may withhold such permission at its sole discretion, or grant such permission upon such terms and conditions as it deems acceptable, such as the execution of a Hold Harmless Agreement or the payment of a re-use fee.

Signature: _____

Date: _____

APPENDIX A

KEY TO LOGS
LOGS OF PRIOR EXPLORATION TRENCHES
LABORATORY TEST DATA

PRIMARY DIVISIONS			GROUP SYMBOL	SECONDARY DIVISIONS
COARSE GRAINED SOILS MORE THAN HALF OF MATERIAL IS LARGER THAN NO. 200 SIEVE SIZE	GRAVELS MORE THAN HALF OF COARSE FRACTION IS LARGER THAN NO. 4 SIEVE	CLEAN GRAVELS (LESS THAN 5% FINES)	GW	Well graded gravels, gravel-sand mixtures, little or no fines.
		GRAVEL WITH FINES	GP	Poorly graded gravels or gravel-sand mixtures, little or no fines.
			GM	Silty gravels, gravel-sand-silt mixtures, non-plastic fines.
		GC	Clayey gravels, gravel-sand-clay mixtures, plastic fines.	
	SANDS MORE THAN HALF OF COARSE FRACTION IS SMALLER THAN NO. 4 SIEVE	CLEAN SANDS (LESS THAN 5% FINES)	SW	Well graded sands, gravelly sands, little or no fines.
		SANDS WITH FINES	SP	Poorly graded sands or gravelly sands, little or no fines.
			SM	Silty sands, sand-silt mixtures, non-plastic fines.
			SC	Clayey sands, sand-clay mixtures, plastic fines.
FINE GRAINED SOILS MORE THAN HALF OF MATERIAL IS SMALLER THAN NO. 200 SIEVE SIZE	SILTS AND CLAYS LIQUID LIMIT IS LESS THAN 50%	ML	Inorganic silts and very fine sands, rock flour, silty or clayey fine sands or clayey silts with slight plasticity.	
		CL	Inorganic clays of low to medium plasticity, gravelly clays, sandy clays, silty clays, lean clays.	
		OL	Organic silts and organic silty clays of low plasticity.	
	SILTS AND CLAYS LIQUID LIMIT IS GREATER THAN 50%	MH	Inorganic silts, micaceous or diatomaceous fine sandy or silty soils, elastic silts.	
		CH	Inorganic clays of high plasticity, fat clays.	
		OH	Organic clays of medium to high plasticity, organic silts.	
		Pt	Peat and other highly organic soils.	
HIGHLY ORGANIC SOILS			Pt	Peat and other highly organic soils.

UNIFIED SOIL CLASSIFICATION SYSTEM (ASTM D-2487)

SILTS AND CLAYS	U.S. STANDARD SERIES SIEVE			CLEAR SQUARE SIEVE OPENINGS			COBBLES	BOULDERS
	200	40	10	4	3/4"	3"		
	SAND			GRAVEL				
	FINE	MEDIUM	COARSE	FINE	COARSE			

GRAIN SIZES

SANDS AND GRAVELS	BLOWS/FOOT [†]
VERY LOOSE	0 - 4
LOOSE	4 - 10
MEDIUM DENSE	10 - 30
DENSE	30 - 50
VERY DENSE	OVER 50

SILTS AND CLAYS	STRENGTH [‡]	BLOWS/FOOT [†]
VERY SOFT	0 - 1/4	0 - 2
SOFT	1/4 - 1/2	2 - 4
FIRM	1/2 - 1	4 - 8
STIFF	1 - 2	8 - 16
VERY STIFF	2 - 4	16 - 32
HARD	OVER 4	OVER 32

RELATIVE DENSITY

[†] Number of blows of 140 pound hammer falling 30 inches to drive a 2 inch O.D. (1-3/8 inch I.D.) split spoon (ASTM D-1586).

[‡] Unconfined compressive strength in tons/sq. ft. as determined by laboratory testing or approximated by the standard penetration test (ASTM D-1586), pocket penetrometer, torvane, or visual observation.

CONSISTENCY

SOIL STRENGTH



UPP GEOTECHNOLOGY
Engineering Geology • Geotechnical Engineering

KEY TO LOGS

LANDS OF COGGINS
San Mateo County, California

PROJECT NO.	DATE
514.01	October, 1988

Figure 5

T-1

N84W

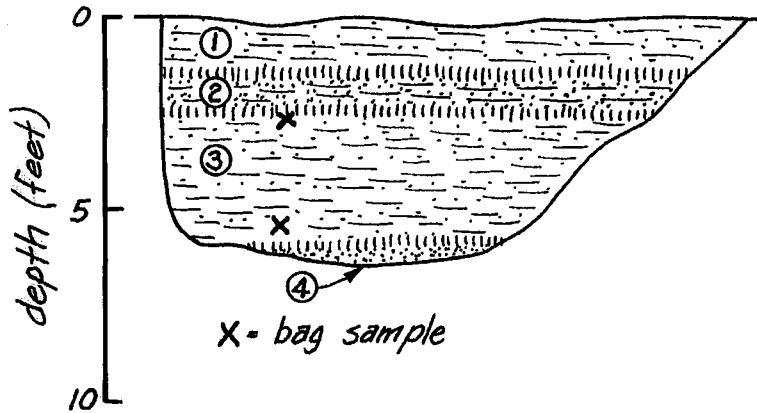

T-2

N9E

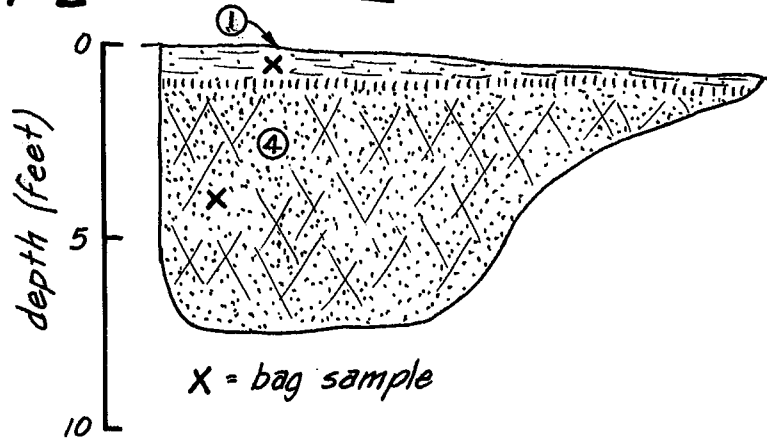

1. **SILTY CLAY (CH)**, slightly moist, dark greyish brown, abundant fine roots, highly plastic, stiff (Topsoil)
2. **SILTY CLAY (CH)**, moist dark greyish brown, trace medium sand, trace roots, hard (Soil)
3. **CLAYEY SILT (ML)**, moist, yellowish brown, minor sand, hard, faint rock texture (Weathered Bedrock)
4. **SANDSTONE**, moist, light grey, fine grain, manganese oxide staining, fractures filled with brown sandy clay, iron oxide stains in coarse lamina, mostly massive, some fine lamination, medium hardness (Bedrock)

Logged by D. Peluso and S. Miller, UPP GEOTECHNOLOGY, INC., September 14, 1988

LOGS OF EXPLORATION TRENCHES 1 AND 2



UPP GEOTECHNOLOGY
Engineering Geology • Geotechnical Engineering

LANDS OF COGGINS
Woodland Vista
San Mateo County, California

APPROVED BY

[Signature]

SCALE

1" = 5'

PROJECT NO.

514.01

DATE

October, 1988

Figure 6

T-3

N66E

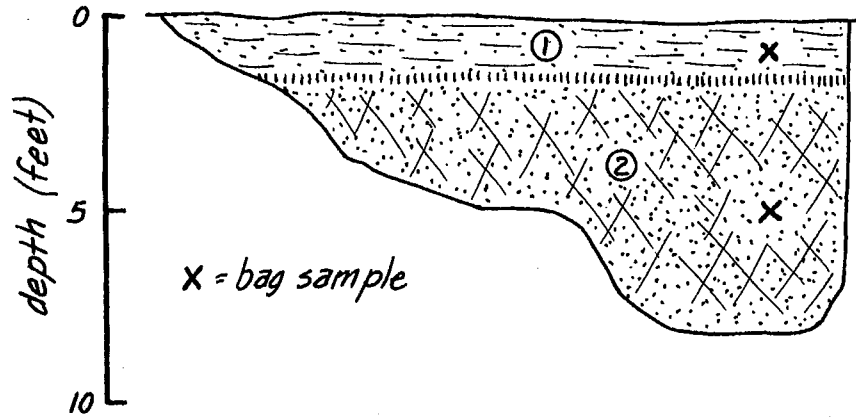

x = bag sample

T-4

N18W

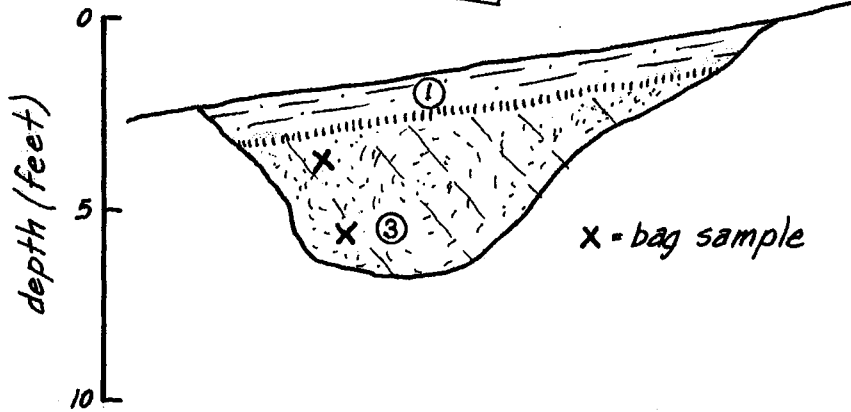

x = bag sample

1. **SILTY CLAY (CH)**, slightly moist, dark greyish brown, trace very coarse sand, some roots and rootlets, highly plastic, firm to stiff (Topsoil)
2. **SANDSTONE**, moist, light grey, fine grain, fractures filled with brown clay, manganese oxide staining on fracture surfaces, some iron oxide stains, mostly massive, some fine lamination, medium hardness (Bedrock)
3. **SILTY CLAY (CH)**, moist, dark brown, minor coarse sand, trace roots, disseminated caliche below 3.5', highly plastic, very stiff to hard (Soil/Colluvium)

Logged by D. Peluso and S. Miller, UPP GEOTECHNOLOGY, INC., September 14, 1988

LOGS OF EXPLORATION TRENCHES 3 AND 4



LANDS OF COGGINS
Woodland Vista
San Mateo County, California

APPROVED BY	SCALE	PROJECT NO.	DATE	
<i>[Signature]</i>	1" = 5'	514.01	October, 1988	Figure 7

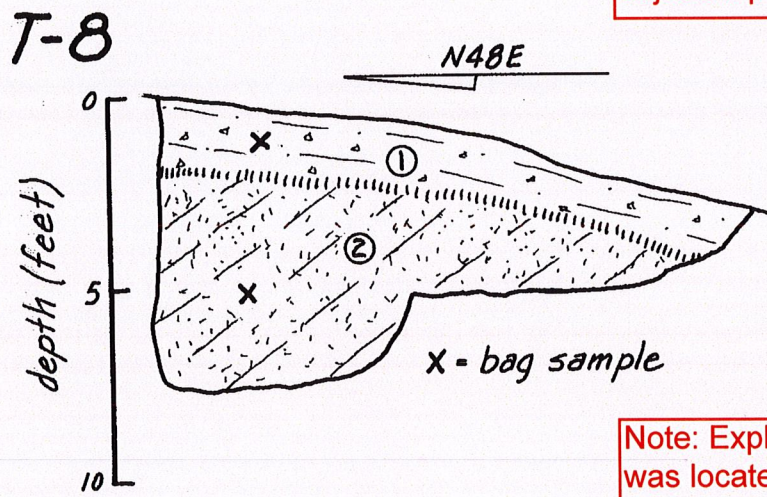
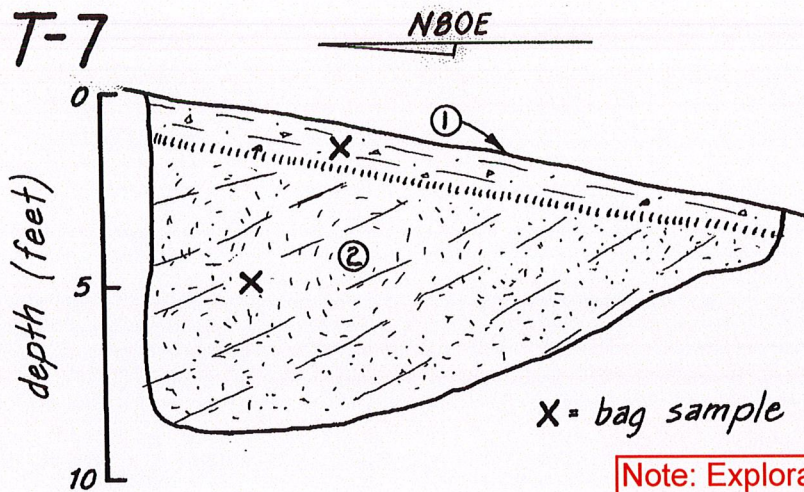

1. **SILTY CLAY (CH)**, slightly moist, dark greyish brown, abundant angular rock fragments to 1/4", abundant fine roots, friable, highly plastic, stiff (Topsoil)
2. **SANDSTONE**, moist, light grey, fine grained, poorly graded, fracture spacing 6-8", fractures filled with highly plastic clay, manganese oxide stains on fracture surfaces, some iron oxide stains, mostly massive, medium hardness (Bedrock)

Logged by D. Peluso and S. Miller, UPP GEOTECHNOLOGY, INC., September 14, 1988

LOGS OF EXPLORATION TRENCHES 7 AND 8

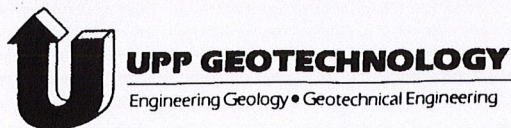

LANDS OF COGGINS
Woodland Vista
San Mateo County, California

APPROVED BY 	SCALE 1" = 5'	PROJECT NO. 514.01	DATE October, 1988	Figure 9

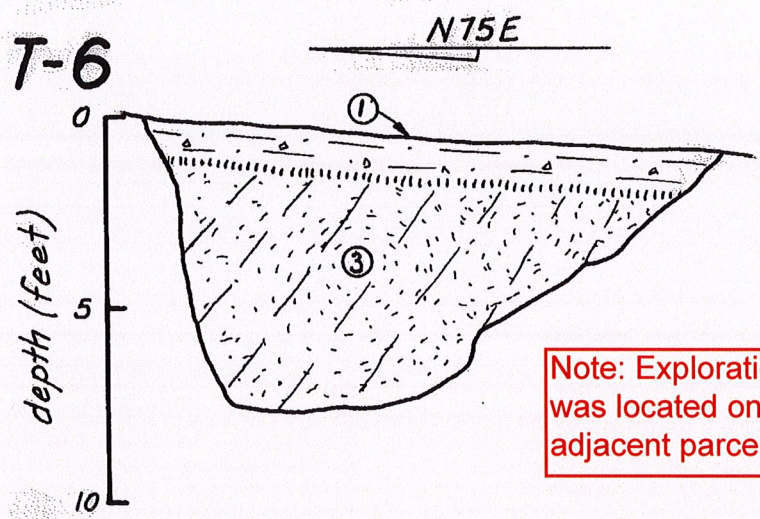
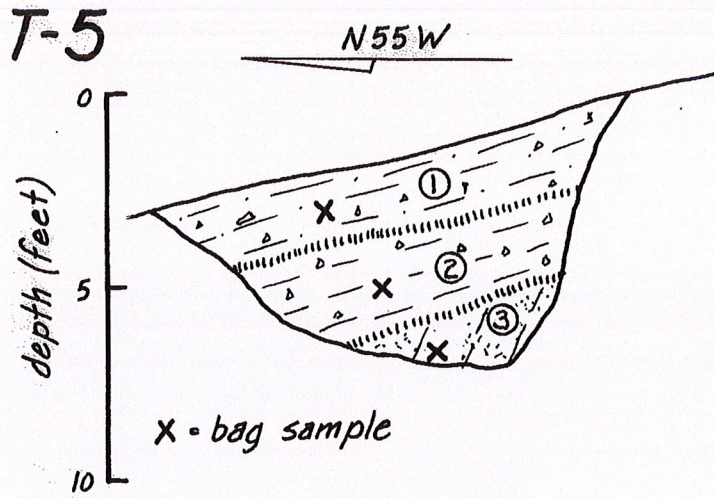

Note: Exploration trench was located on an adjacent parcel

1. **SILTY CLAY (CH)**, slightly moist, dark greyish brown, abundant angular rock fragments to 1/4", friable, abundant fine roots, highly plastic, stiff (Topsoil)
2. **GRAVELLY CLAY (CL)**, moist, brown, abundant angular weathered sandstone fragments to 5", trace large roots, friable, stiff (Colluvium)
3. **SANDSTONE**, moist, light grey, fine grained, poorly graded, fracture spacing 5-8", fractures filled with highly plastic clay, medium hardness, mostly massive, manganese oxide stains on fracture surfaces, some iron oxide stains (Bedrock)

Logged by D. Peluso and S. Miller, UPP GEOTECHNOLOGY, INC., September 14, 1988

LOGS OF EXPLORATION TRENCHES 5 AND 6

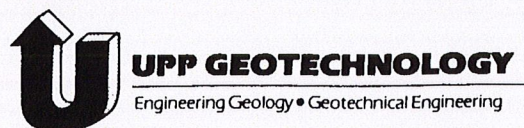

LANDS OF COGGINS
Woodland Vista
San Mateo County, California

APPROVED BY <i>[Signature]</i>	SCALE 1" = 5'	PROJECT NO. 514.01	DATE October, 1988	Figure 8

T-9

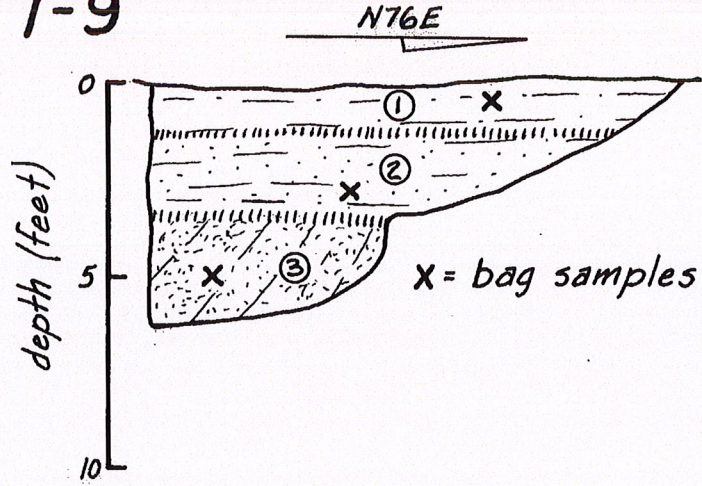

T-10

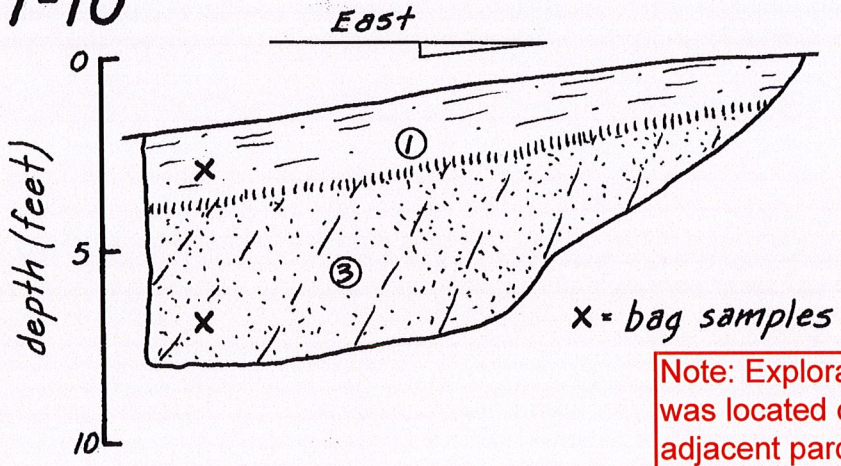

Note: Exploration trench was located on an adjacent parcel

1. **SILTY CLAY (CH)**, slightly moist, dark greyish brown, some angular rock fragments to 1/4", abundant fine roots, friable, highly plastic, stiff (Topsoil)
2. **SILTY CLAY (CL)**, moist, dark reddish brown, trace sand, fine rootlets, low to medium plasticity, stiff (Soil)
3. **SANDSTONE**, moist, light grey, fine grained sand, poorly graded, fracture spacing 6-8", fractures filled with highly plastic clay, manganese oxide stains on fracture surfaces, some iron oxide stains, mostly massive, medium hardness (Bedrock)

Logged by D. Peluso and S. Miller, UPP GEOTECHNOLOGY, INC., September 14, 1988

LOGS OF EXPLORATION TRENCHES 9 AND 10

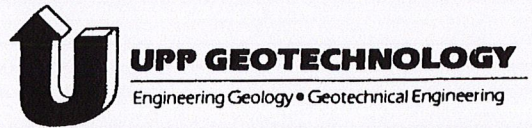

LANDS OF COGGINS
Woodland Vista
San Mateo County, California

APPROVED BY	SCALE	PROJECT NO.	DATE	
<i>DP</i>	1" = 5'	514.01	October, 1988	Figure 10

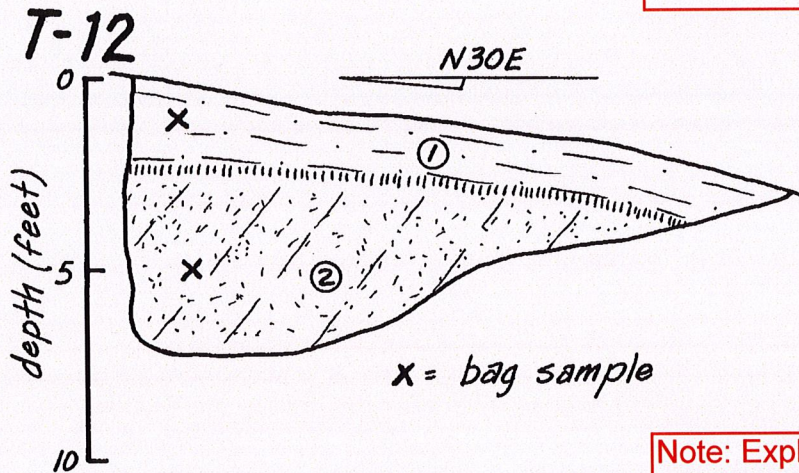
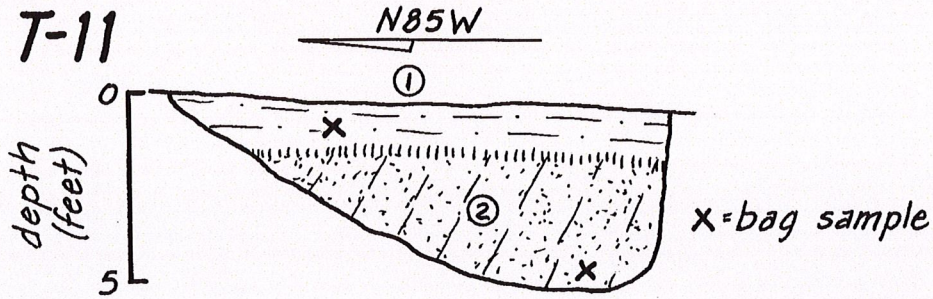

1. **SILTY CLAY (CH)**, slightly moist, dark greyish brown, some angular rock fragments to 1/4", abundant fine roots, friable, highly plastic, stiff (Topsoil)
2. **SILTSTONE**, moist, greyish brown, abundant fine sand, fracture spacing 3-5", manganese oxide staining on fracture surfaces, mostly massive, medium hardness (Bedrock)

Logged by D. Peluso and S. Miller, UPP GEOTECHNOLOGY, INC., September 14, 1988

LOGS OF EXPLORATION TRENCHES 11 AND 12

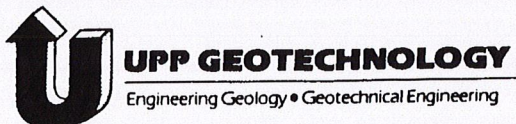

LANDS OF COGGINS
Woodland Vista
San Mateo County, California

APPROVED BY	SCALE	PROJECT NO.	DATE	Figure 11
	1" = 5'	514.01	October, 1988	

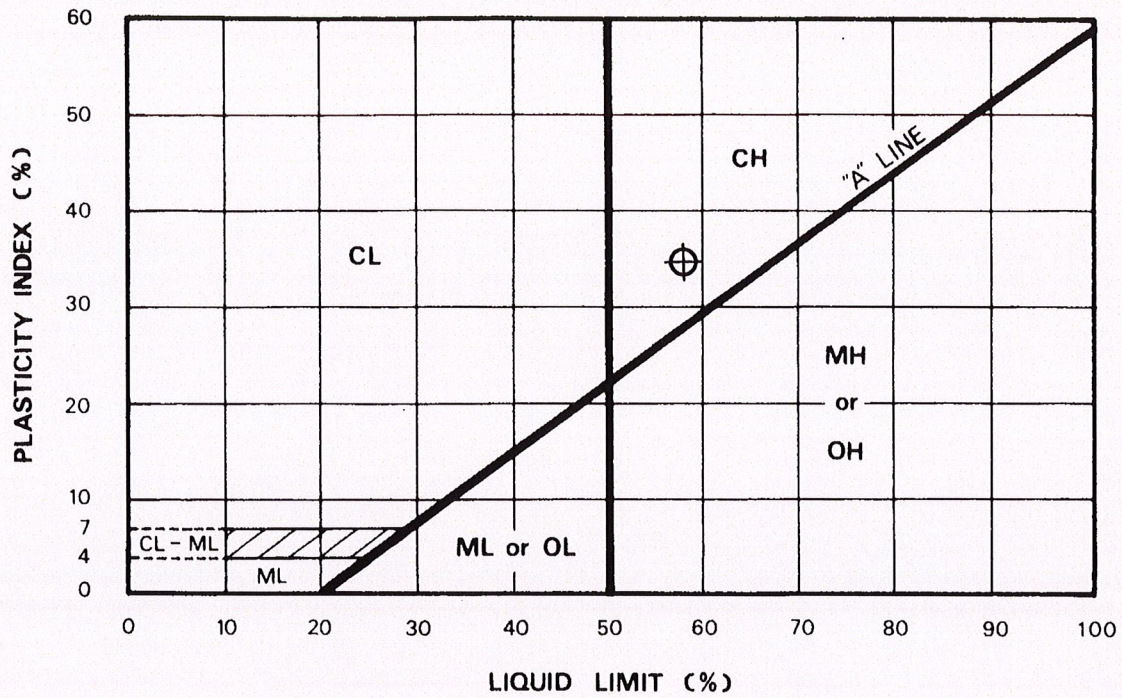

KEY SYMBOL	BORING NO.	SAMPLE DEPTH (feet)	NATURAL WATER CONTENT %	LIQUID LIMIT %	PLASTICITY INDEX %	PASSING NO. 200 SIEVE %	LIQUIDITY INDEX	UNIFIED SOIL CLASSIFICATION SYMBOL
⊕	T-4	2.0-3.5'	17	58	35	80	-0.171	CH

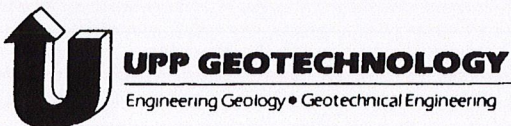

PLASTICITY CHART

LANDS OF COGGINS
San Mateo County, California

PROJECT NO.	DATE
514.01	October, 1988

Figure 12

Trench No.	Sample Depth (ft)	Moisture Content (%)	Dry Density (pcf)	Shear * Strength (ksf)
T1	1.0	11		
	2.0	22		
	2.8	24	88	1.3
	5.5	34	86	2.3
	6.0	22		
T2	0.5	10		
	4.0	30		
T3	0.8	18		
	5.0	29		
T4	2.0	17		
	3.5	16		
T5	1.0	20		
	3.5	25		
	5.5	23		
T6	0.5	13		
	4.0	27		
T7	0.5	10		
	5.0	28		
T8	1.0	11		
	5.0	26		
T9	0.5	10		
	3.5	26	76	
	5.0	24		
T10	1.0	15		
	4.5	28		
T11	1.0	12		
	4.0	32		
T12	1.0	12		
	5.0	24		

* Unconfined Compression Test

SUMMARY OF LABORATORY TEST RESULTS



LANDS OF COGGINS
Woodland Vista
San Mateo County, California

APPROVED BY

BD

SCALE

N/A

PROJECT NO.

514.01

DATE

October, 1988

Table II